

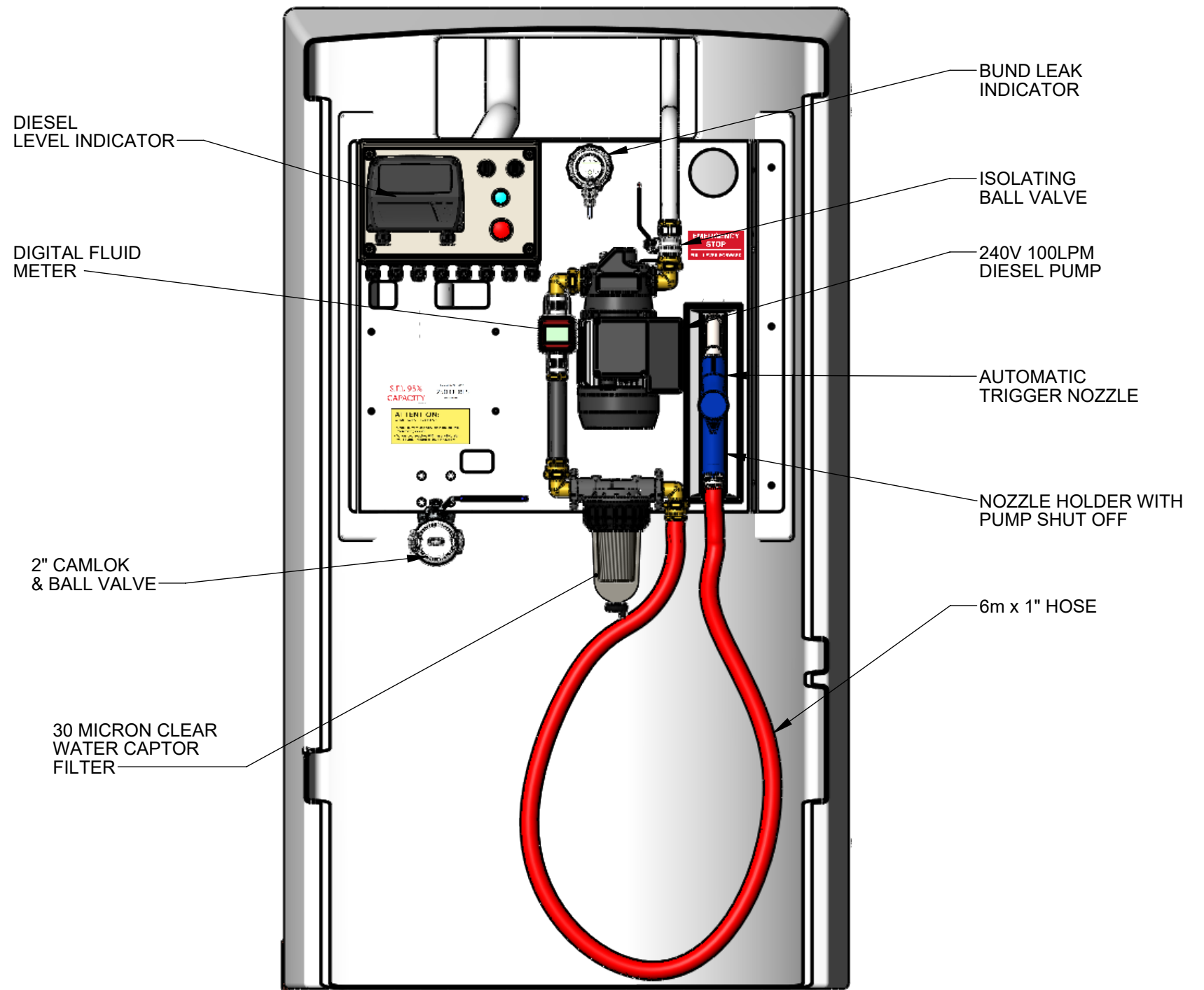



3,300L MODEL SHOWN



SECTION THRU CABINET FRONT
SCALE 1 : 10

				ALL TOLERANCES UNLESS OTHERWISE STATED $\pm 10\text{mm} / \pm 1^\circ$		DO NOT SCALE, USE DIMENSIONS. ALL DIMENSIONS ARE IN mm							
				 161 KARINE STREET SWAN HILL, VIC 3585 Ph. (03) 5033 9000 Fx: (03) 5033 0224		DESCRIPTION		3300L DIESEL BUNDED TANK		A3 SHEET SIZE	SCALE: 1:20		
						PRODUCT CODE		DMDS3300R			 		
						MATERIAL							
				COLOUR				DRAWN		ZP	11/12/2020	1/2	Rev: A
A	ZP	11/12/2020	FIRST RELEASE	© POLYMASTER GROUP		LEVEL		DRAWING No.		DMDS3300R-01-01			
REV	DRAWN	DATE	PARTICULARS										

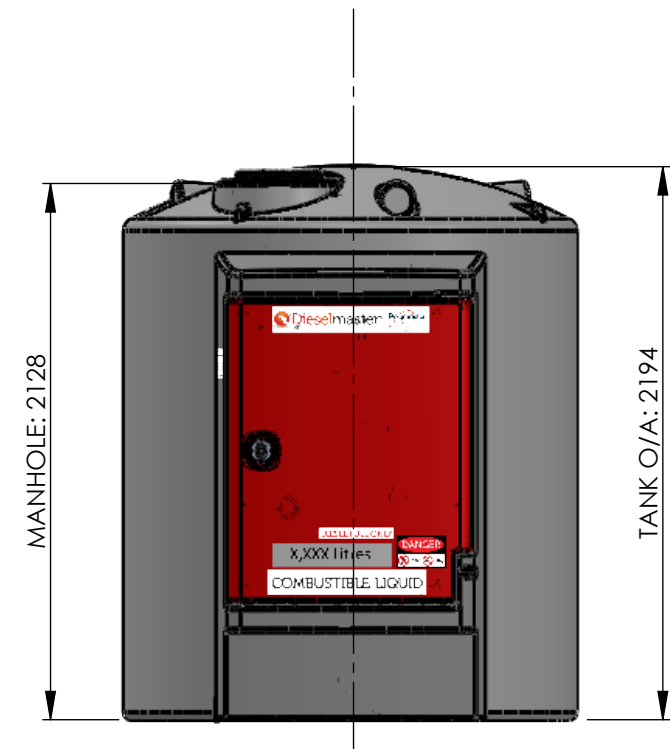
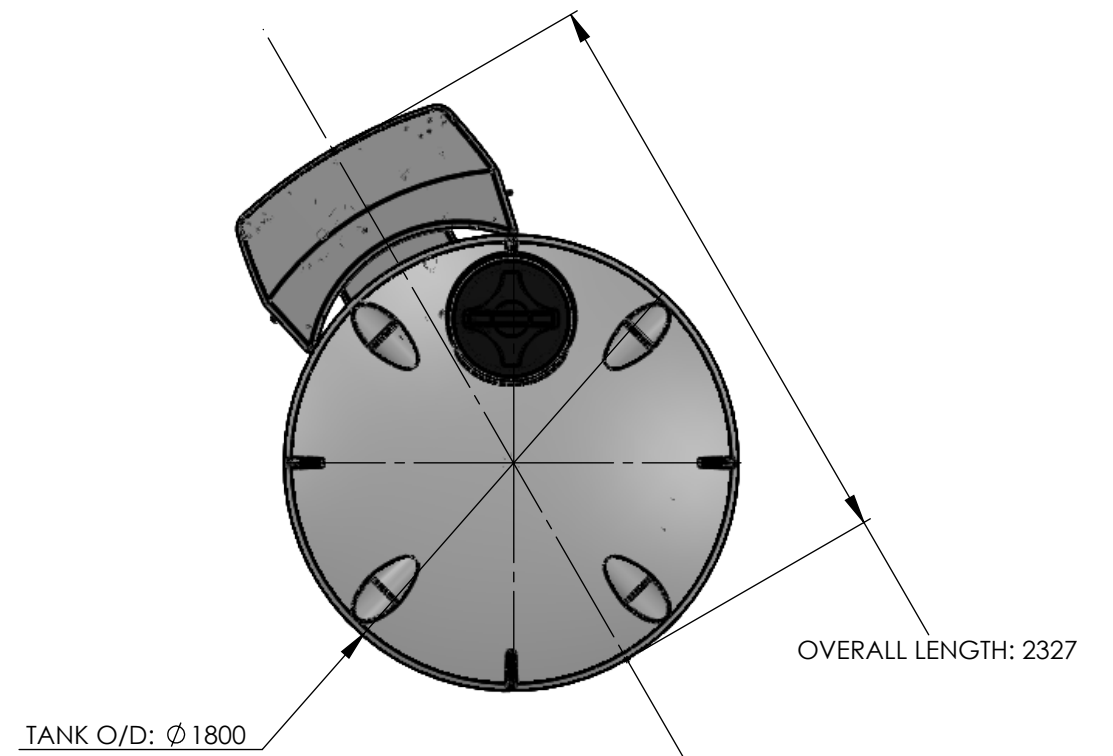
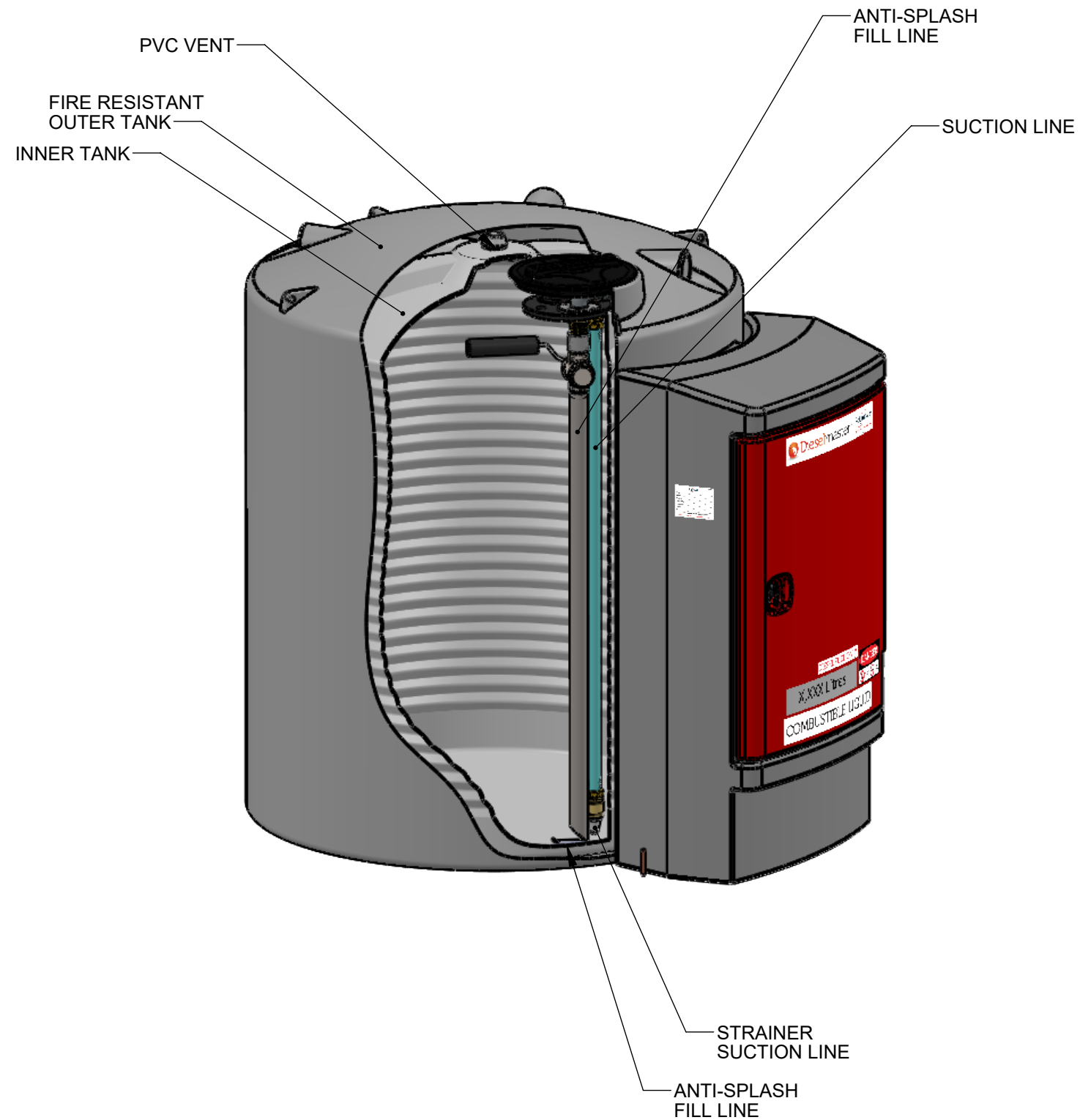

REV	DRAWN	DATE	PARTICULARS
A	ZP	11/12/2020	FIRST RELEASE

ALL TOLERANCES UNLESS OTHERWISE STATED $\pm 10\text{mm} / \pm 1^\circ$

Polymaster

161 KARINE STREET
SWAN HILL, VIC
3585
Ph. (03) 5033 9000
Fx: (03) 5033 0224

© POLYMASTER GROUP

DESCRIPTION		DO NOT SCALE, USE DIMENSIONS. ALL DIMENSIONS ARE IN mm	
3300L DIESEL BUNDED TANK		SCALE: 1:20	
PRODUCT CODE		A3 SHEET SIZE	
DMDS3300R		DRAWN	
MATERIAL		ZP	
COLOUR		11/12/2020	
LEVEL	DRAWING No.	2	2
	DMDS3300R-01-01	Rev: A	

MANHOLE: 2128

TANK O/A: 2194

MANHOLE: 2128

TANK O/A: 2194